

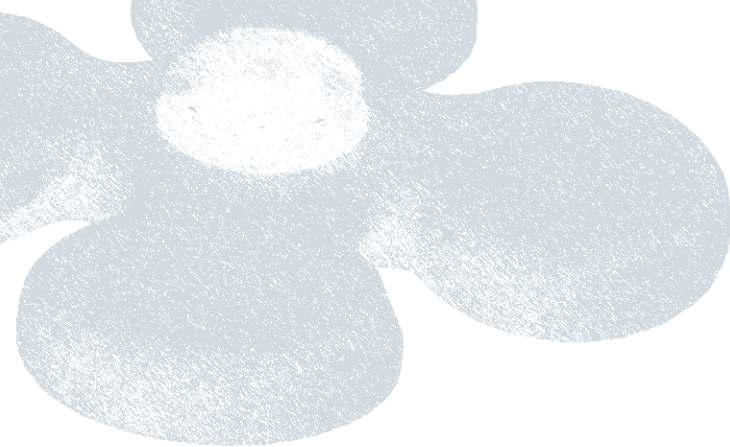

program
magazynowy
2013

SCHWINN

A World of Daily Innovation



	DŁUGOŚĆ	LENGHT
	SZEROKOŚĆ	WIDTH
	WYSOKOŚĆ	HEIGHT
	ŚREDNICA	DIAMETRE
	ROZSTAW	BORE SPACING
	DŁUGOŚĆ	LENGHT
	SZEROKOŚĆ	WIDTH
	WYSOKOŚĆ	HEIGHT
	NOŚNOŚĆ w kg	LOAD-BEARING CAPACITY in kg
	SZEROKOŚĆ	WIDTH
	GRUBOŚĆ MATERIAŁU	MATERIAL THICKNESS
	GRUBOŚĆ FRONTU	FRONT THICKNESS
	WYSOKOŚĆ	HEIGHT
	SZEROKOŚĆ	WIDTH



1



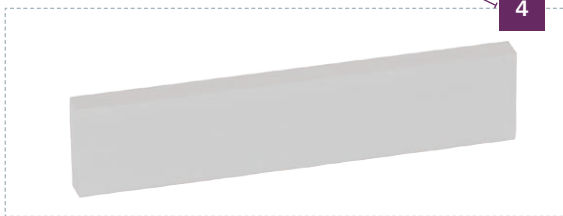

4

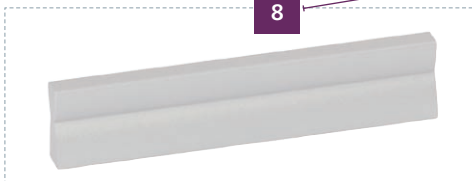

8

5



	Art. Nr / Art.-No.	Wykonanie / Finish					
1	3621/32	aluminium aluminium	52	8	25	-	32
2	3621/128	aluminium aluminium	148	8	25	-	128
3	3621/160	aluminium aluminium	180	8	25	-	160
4	3621/320	aluminium aluminium	340	8	25	-	320
5	3623/32	aluminium aluminium	52	9	20	-	32
6	3623/128	aluminium aluminium	148	9	20	-	128
7	3623/160	aluminium aluminium	180	9	20	-	160
8	3623/320	aluminium aluminium	340	9	20	-	320



9



12

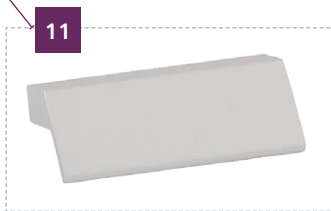
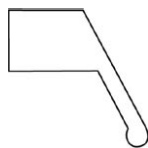





11

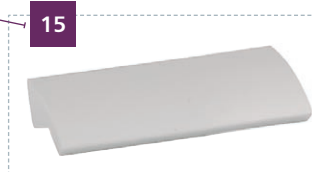

13



15





	Art. Nr / Art.-No.	Wykonanie / Finish					
9	3625/32	aluminium aluminium	52	18	19	-	32
10	3625/96	aluminium aluminium	116	18	19	-	96
11	3625/256	aluminium aluminium	276	18	19	-	256
12	3625/64	chrom polished chrome	84	18	19	-	64
13	3627/256	aluminium aluminium	276	16	18	-	256
14	3627/128	aluminium aluminium	148	16	18	-	128
15	3627/32	aluminium aluminium	52	16	18	-	32
16	3627/32	chrom polished chrome	52	16	18	-	32

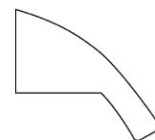

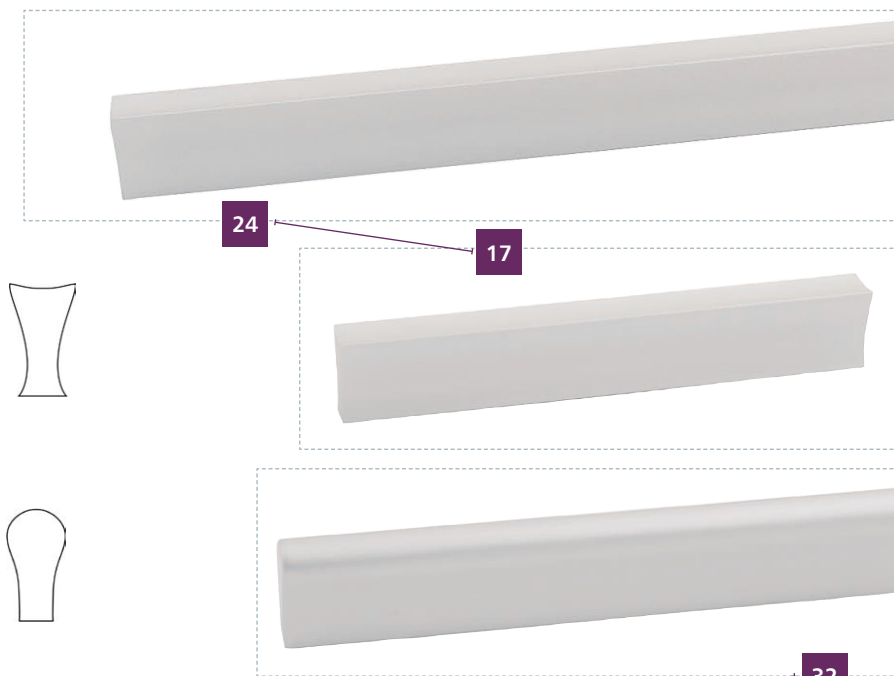
16





	Art. Nr / Art.-No.	Wykonanie / Finish					
17	4067/32	aluminium aluminium	52	14	24	-	32
18	4067/128	aluminium aluminium	148	14	24	-	128
19	4067/160	aluminium aluminium	180	14	24	-	160
20	4067/256	aluminium aluminium	276	14	24	-	256
21	4067/384	aluminium aluminium	404	14	24	-	384
22	4067/448	aluminium aluminium	468	14	24	-	448
23	4067/544	aluminium aluminium	564	14	24	-	544
24	4067/736	aluminium aluminium	756	14	24	-	736
25	4066/32	aluminium aluminium	52	12	24	-	32
26	4066/64	aluminium aluminium	84	12	24	-	64
27	4066/128	aluminium aluminium	148	12	24	-	128
28	4066/192	aluminium aluminium	212	12	24	-	192
29	4066/256	aluminium aluminium	276	12	24	-	256
30	4066/384	aluminium aluminium	404	12	24	-	384
31	4066/544	aluminium aluminium	564	12	24	-	544
32	4066/1056	aluminium aluminium	1076	12	24	-	1056





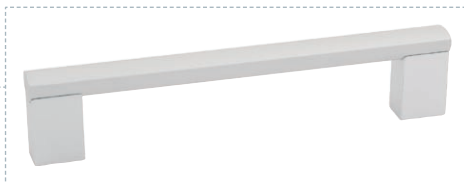

33-43

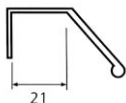
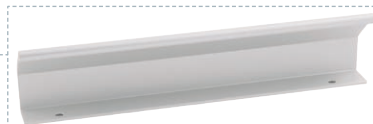

44-47





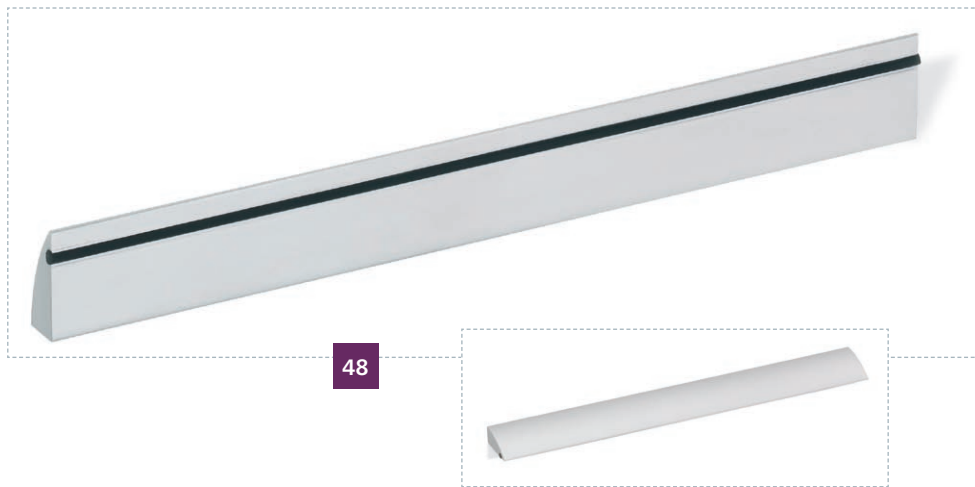

	Art. Nr / Art.-No.	Wykonanie / Finish					
33	4211/128	aluminium aluminium	140	16	36		128
34	4211/160	aluminium aluminium	172	16	36		160
35	4211/224	aluminium aluminium	236	16	36		224
36	4211/256	aluminium aluminium	268	16	36		256
37	4211/320	aluminium aluminium	332	16	36		320
38	4211/416	aluminium aluminium	428	16	36		416
39	4211/512	aluminium aluminium	524	16	36		512
40	4211/608	aluminium /dodatkowa stopka/ aluminium /additional base/	620	16	36		608
41	4211/704	aluminium /dodatkowa stopka/ aluminium /additional base/	716	16	36		704
42	4211/800	aluminium /dodatkowa stopka/ aluminium /additional base/	812	16	36		800
43	4211/1088	aluminium /dodatkowa stopka/ aluminium /additional base/	1100	16	36		1088
44	4299/32	aluminium aluminium	64	45	26	2,0	32
45	4299/160	aluminium aluminium	200	45	26	2,0	160
46	4299/224	aluminium aluminium	264	45	26	2,0	224
47	4299/384	aluminium aluminium	424	45	26	2,0	384



48



49-55

	Art. Nr / Art.-No.	Wykonanie / Finish					
48	3718/192	aluminium/czarna guma aluminium/black rubber	212	10	25	192	
49	3758/128	aluminium/tworzywo aluminium/plastic	228	21	28	128	
50	3758/160	aluminium/tworzywo aluminium/plastic	260	21	28	160	
51	3758/224	aluminium/tworzywo aluminium/plastic	324	21	28	224	
52	3758/256	aluminium/tworzywo aluminium/plastic	356	21	28	256	
53	3758/320	aluminium/tworzywo aluminium/plastic	420	21	28	320	
54	3758/416	aluminium/tworzywo aluminium/plastic	516	21	28	416	
55	3758/512	aluminium/tworzywo aluminium/plastic	612	21	28	512	







56



63



64

	Art. Nr / Art.-No.	Wykonanie / Finish					
56	2966/128	aluminium aluminium	139	20	28	128	
57	2966/160	aluminium aluminium	171	20	28	160	
58	2966/224	aluminium aluminium	235	20	28	224	
59	2966/256	aluminium aluminium	267	20	28	256	
60	2966/320	aluminium aluminium	331	20	28	320	
61	2966/416	aluminium aluminium	427	20	28	416	
62	2966/512	aluminium aluminium	523	20	28	512	
63	2966/608	aluminium aluminium	619	20	28	608	
64	4241/128	aluminium aluminium	146	20	28	128	



65

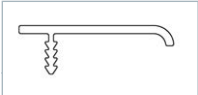

66





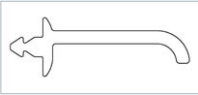

67

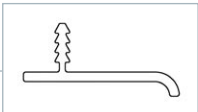

68







	Art. Nr / Art.-No.	Wykonanie / Finish	   
65	3677/2000	aluminium aluminium	2000 2/5 38 2.0
66	3678/2000	aluminium aluminium	2000 5 1,5 2.0
67	3679/2000	aluminium aluminium	2000 9 22 2.0
68	3680/2000	aluminium aluminium	2000 2/5 32 2.0



69-75





	Art. Nr / Art.-No.	Wykonanie / Finish					
69	2389/96	mat chrom /mat chrome/ efekt stali nierdzewnej /stainless steel effect/	104	18	30	-	96
70	2389/128	mat chrom /mat chrome/ chrom /polished chrome/ efekt stali nierdzewnej /stainless steel effect/	135	20	30	-	128
71	2389/160	mat chrom /mat chrome/ efekt stali nierdzewnej /stainless steel effect/	168	20	30	-	160
72	2389/256	chrom / polished chrome/ mat chrom /mat chrome/	264	20	30	-	256
73	2389/320	mat chrom /mat chrome/ efekt stali nierdzewnej /stainless steel effect/	330	20	30	-	320
74	2389/384	chrom / polished chrome/ mat chrom /mat chrome/	392	20	30	-	384
75	2389/480	chrom / polished chrome/ mat chrom /mat chrome/ efekt stali nierdzewnej /stainless steel effect/	488	20	30	-	480



76-85



	Art. Nr / Art.-No.	Wykonanie / Finish					
76	2576/32	mat chrom /mat chrome/ chrom /polished chrome/	57	8	26		32
77	2576/64	mat chrom /mat chrome/ chrom /polished chrome/	89	8	26		64
78	2576/96	chrom /polished chrome/ mat chrom /mat chrome/ chrom /polished chrome/	113	8	27		96
79	2576/128	mat chrom /mat chrome/ chrom /polished chrome/ efekt stali nierdzewnej /stainless steel effect/	150	8	27		128
80	2576/160	mat chrom /mat chrome/ chrom /polished chrome/ efekt stali nierdzewnej /stainless steel effect/	186	9	27		160
81	2576/192	mat chrom /mat chrome/ chrom /polished chrome/ efekt stali nierdzewnej /stainless steel effect/	222	9	28		192
82	2576/256	mat chrom /mat chrome/ chrom /polished chrome/ efekt stali nierdzewnej /stainless steel effect/	290	9	28		256
83	2576/320	mat chrom /mat chrome/ chrom /polished chrome/ efekt stali nierdzewnej /stainless steel effect/	359	9	28		320
84	2576/480	mat chrom /mat chrome/ chrom /polished chrome/ efekt stali nierdzewnej /stainless steel effect/	518	9	28		480
85	2576/704	mat chrom - dodatkowa stopka /mat chrome - additional base/ chrom /polished chrome/	740	10	28		704



87







86



89



88

	Art. Nr / Art.-No.	Wykonanie / Finish					
86	Z005	chrom polished chrome	120	40	26	32	
87	Z005	chrom z dekorem polished chrome with decoration	120	40	26	32	
88	Z003	mat chrom mat chrome	80	80	22	64	
89	Z003	chrom polished chrome	80	80	22	64	



90-91







92-93



94-95







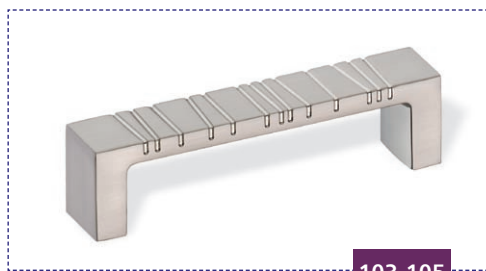
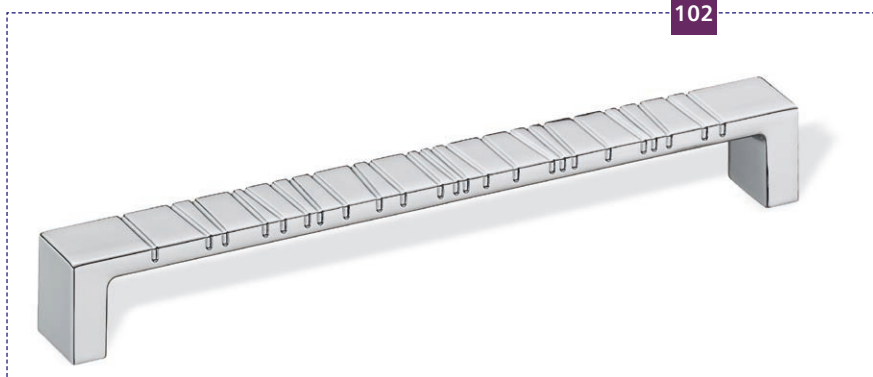
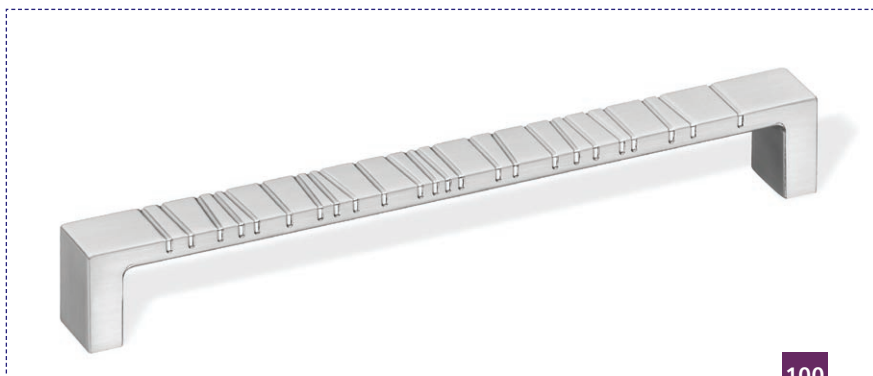

96-97

	Art. Nr / Art.-No.	Wykonanie / Finish					
90	2935/32	mat nikiel szczotkowany brushed mat nickel	50	50	23	32	
91	2935/64	mat nikiel szczotkowany brushed mat nickel	73	73	25	64	
92	2935/32	mat chrom mat chrome	50	50	23	32	
93	2935/64	mat chrom mat chrome	73	73	25	64	
94	2935/32	chrom polished chrome	50	50	23	32	
95	2935/64	chrom polished chrome	73	73	25	64	
96	2935/32	chrom z dekorem polished chrome with decoration	50	50	23	32	
97	2935/64	chrom z dekorem polished chrome with decoration	73	73	25	64	
98	2935/32	efekt stali nierdzewnej stainless steel effect	50	50	23	32	
99	2935/64	efekt stali nierdzewnej stainless steel effect	73	73	25	64	



98-99



	Art. Nr / Art.-No.	Wykonanie / Finish					
100	Z054/192	mat chrom mat chrome	203	22	27	192	
101	Z054/192	chrom polished chrome	203	22	27	192	
102	Z054/192	efekt stali nierdzewnej stainless steel effect	203	22	27	192	
103	Z054/96	mat chrom mat chrome	107	22	27	96	
104	Z054/96	chrom polished chrome	107	22	27	96	
105	Z054/96	efekt stali nierdzewnej stainless steel effect	107	22	27	96	





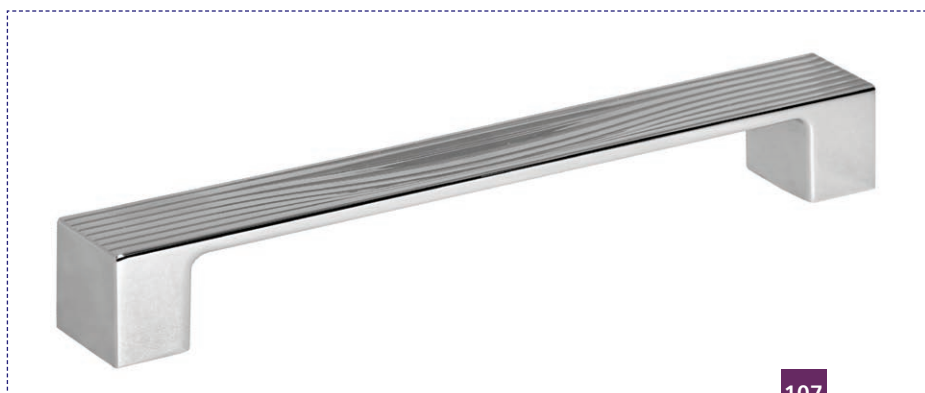

106

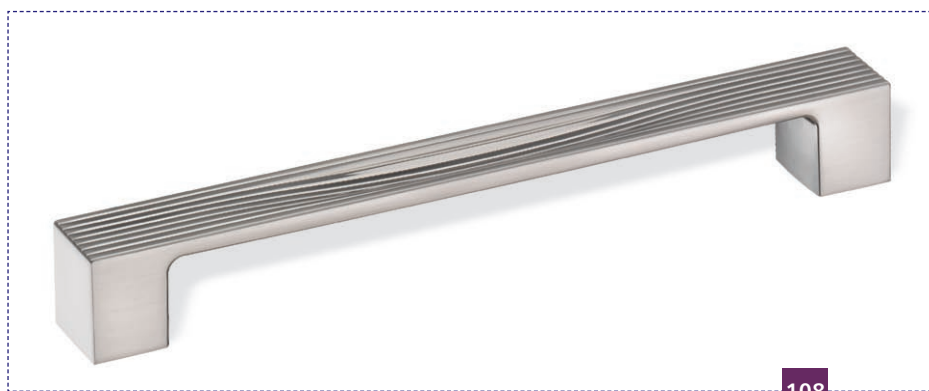

107



108

	Art. Nr / Art.-No.	Wykonanie / Finish					
106	Z019/224	mat chrom mat chrome	234	29	30	224	
107	Z019/224	chrom polished chrome	234	29	30	224	
108	Z019/224	efekt stali nierdzewnej stainless steel effect	234	29	30	224	



109





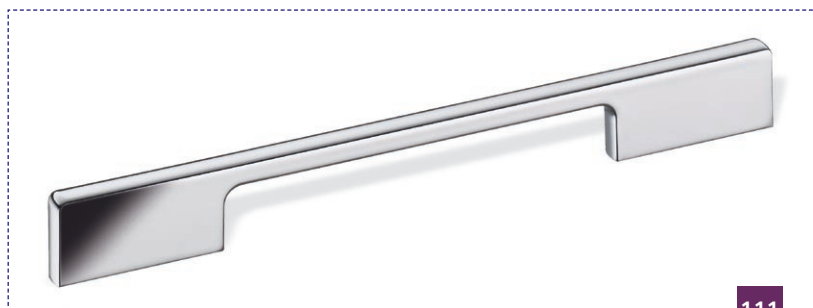

110

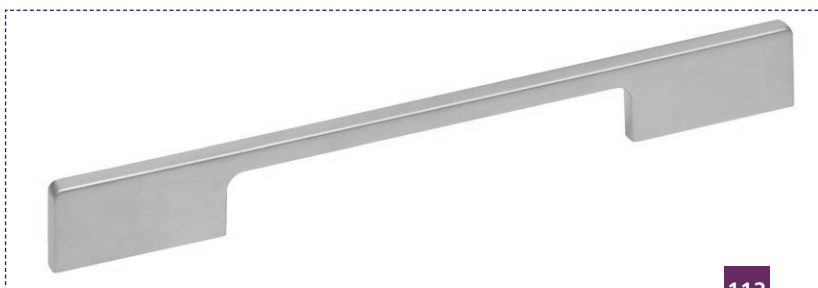





111



112

	Art. Nr / Art.-No.	Wykonanie / Finish					
109	Z047/160/192	chrom polished chrome	204	20	29	160/192	
110	Z047/160/192	mat chrom mat chrome	204	20	29	160/192	
111	Z011/160/224	chrom polished chrome	249	10	29	160/224	
112	Z011/160/224	mat chrom mat chrome	249	10	29	160/224	



	Art. Nr / Art.-No.	Wykonanie / Finish					
113	Z036/160	chrom polished chrome	170	31	32		160
114	Z036/160	mat chrom mat chrome	170	31	32		160
115	Z037/192	chrom polished chrome	233	18	25		192
116	Z037/192	efekt stali nierdzewnej stainless steel effect	233	18	25		192

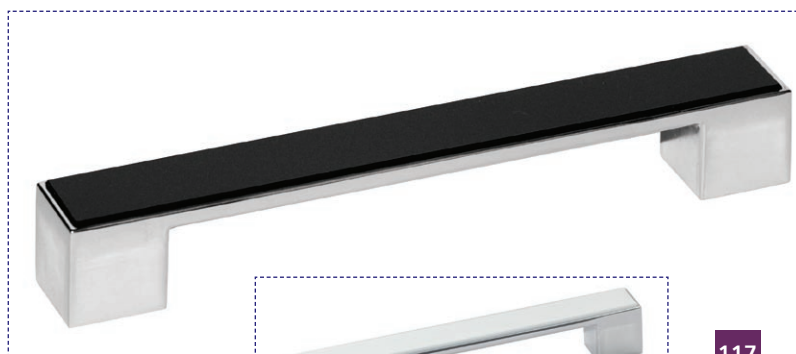

117



118



120

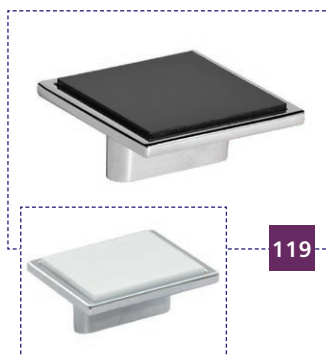

119

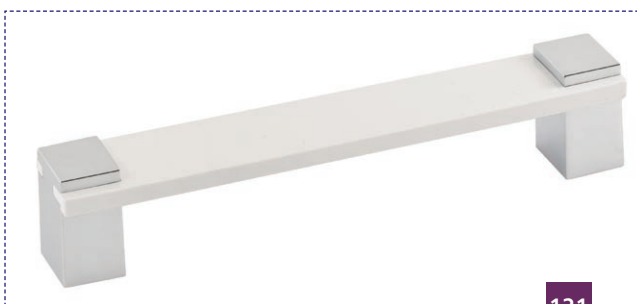

121





	Art. Nr / Art.-No.	Wykonanie / Finish				
117	Z040/160	chrom/czarny akryl - polished chrome/black acrylic chrom/perła akryl - polished chrome/pearl-grey acrylic	184	25	27	160
118	Z030	mat chrom /mat chrome/ chrom /polished chrome/	58	58	23	32
119	Z030	chrom/czarny akryl - polished chrome/black acrylic chrom/perła akryl - polished chrome/pearl-grey acrylic	58	58	23	32
120	K113/128	chrom/czame tworzywo polished chrome/black plastic	153	34	30	128
121	K113/128	chrom/białe tworzywo polished chrome/white plastic	153	34	30	128

122-125

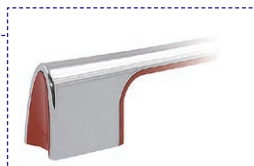

126-129



	Art. Nr / Art.-No.	Wykonanie / Finish				
122	2972/160	mat chrom / bordowy RAL 3004 mat chrome / maroon RAL 3004	202	10	30	160
123	2972/160	mat chrom / czarny RAL 9005 mat chrome / black RAL 9005	202	10	30	160
124	2972/160	mat chrom / beżowy RAL 1015 mat chrome / beige RAL 1015	202	10	30	160
125	2972/160	mat chrom / biały RAL 9010 mat chrome / white RAL 9010	202	10	30	160
126	2972/160	chrom / czarny RAL 9005 polished chrome / black RAL 9005	202	10	30	160
127	2972/160	chrom / bordowy RAL 3004 polished chrome / maroon RAL 3004	202	10	30	160
128	2972/160	chrom / beżowy RAL 1015 polished chrome / beige RAL 1015	202	10	30	160
129	2972/160	chrom / biały RAL 9010 polished chrome / white RAL 9010	202	10	30	160





130

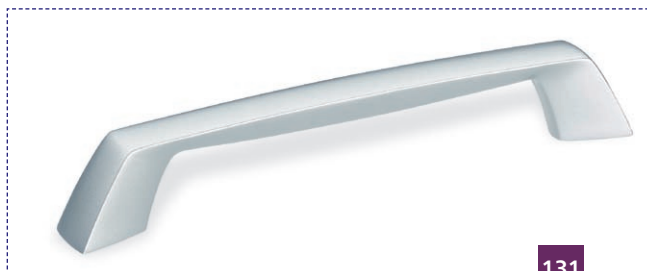



131



132



133

	Art. Nr / Art.-No.	Wykonanie / Finish					
130	2930/160	efekt stali nierdzewnej stainless steel effect	192	19	32	160	
131	2930/160	mat chrom mat chrome	192	19	32	160	
132	2930/160	chrom polished chrome	192	19	32	160	
133	2580/192	mat chrom mat chrome	219	10	29	192	



136



135

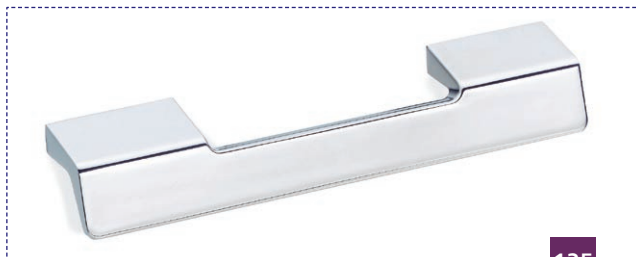

135





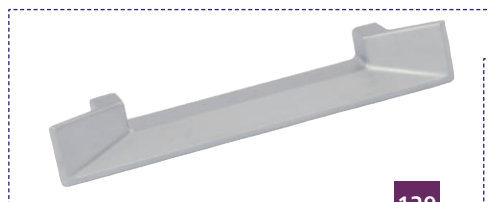

137-138

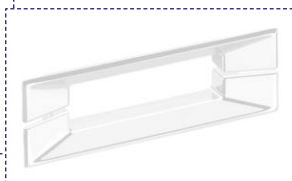

139



	Art. Nr / Art.-No.	Wykonanie / Finish					
134	Z114	chrom /polished chrome/ efekt stali nierdzewnej /stainless steel effect/	147	12	20	-	128
135	2987/160	mat chrom /mat chrome/ chrom /polished chrome/	170	28	28	-	96/160
136	2975	mat chrom /mat chrome/		41	80		32
137	Z012	chrom /polished chrome/	193	31	19	-	160
138	Z012	efekt stali nierdzewnej /stainless steel effect/	193	31	19	-	160
139	2988	mat chrom /mat chrome/	144	23	21	-	96



140



142



141



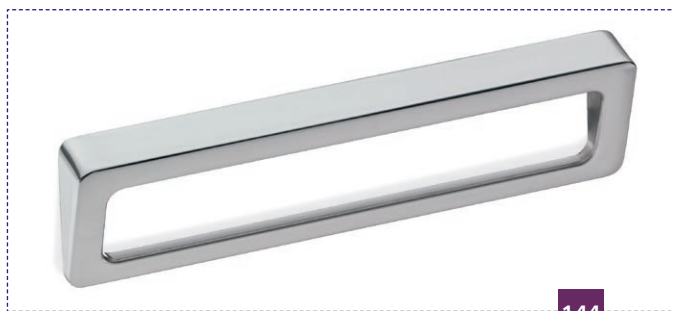

143



144



145

	Art. Nr / Art.-No.	Wykonanie / Finish				\varnothing	\dots
140	2973/192	mat chrom /mat chrome/ mat nikiel /mat nickel/	202	9	30	-	192
141	2973/96	mat chrom /mat chrome/ mat nikiel /mat nickel/	106	9	27	-	96
142	2406/32	mat chrom /mat chrome mat nikiel /mat nickel	56	12	29	-	32
143	2406/128/160	mat chrom /mat chrome mat nikiel /mat nickel	168	15	35	-	128/160
144	Z149	chrom /polished chrome/	170	45	21	-	160
145	2977	mat chrom /mat chrome/	77	77	20	-	64

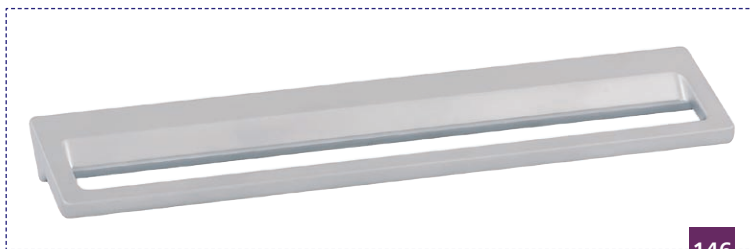

146

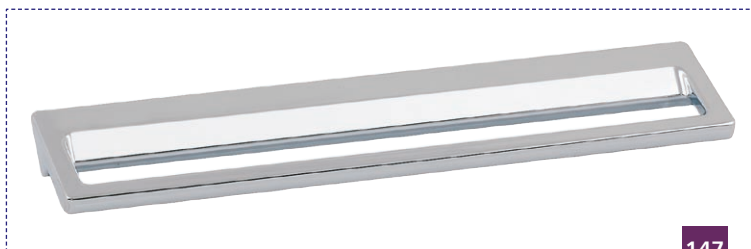

147



148







149



150



151

	Art. Nr / Art.-No.	Wykonanie / Finish					
146	2970/192	mat chrom mat chrome	200	39	26	-	192
147	2970/192	chrom polished chrome	200	39	26	-	192
148	2970/32	mat chrom mat chrome	40	39	26	-	32
149	2970/32	chrom polished chrome	40	39	26	-	32
150	2974	mat chrom mat chrome	74	60	27	-	64
151	2974	chrom polished chrome	74	60	27	-	64

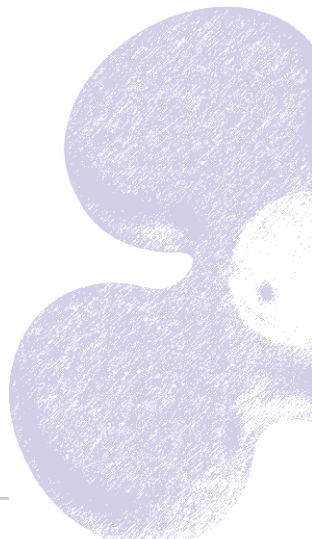



152



154







153







155



156

	Art. Nr / Art.-No.	Wykonanie / Finish					
152	Z008/256	efekt stali nierdzewnej /stainless steel effect/ chrom /polished chrome/	267	25	26	256	
153	Z008/96	efekt stali nierdzewnej /stainless steel effect/ chrom /polished chrome/	107	21	26	96	
154	Z108	chrom polished chrome	36	36	23	0+16	
155	Z070/160	chrom polished chrome	168	18	27	160	
156	Z065	chrom polished chrome	160	20	27	128	



	Art. Nr / Art.-No.	Wykonanie / Finish					
157	2891/192	chrom /polished chrome/ efekt stali nierdzewnej /stainless steel effect/	202	9	20		192
158	2891/128	chrom /polished chrome/ efekt stali nierdzewnej /stainless steel effect/	140	9	20		128
159	2891/64	chrom polished chrome	75	9	20		64
160	2891/32	chrom polished chrome	42	9	20		32
161	Z111	chrom polished chrome	140	50	22		128
162	Z072	chrom /polished chrome/ efekt stali nierdzewnej /stainless steel effect/		27	106		96
163	Z010	mat chrom mat chrome	74	37	19		64
164	Z010	chrom polished chrome	74	37	19		64



165



166



167



168







169



170



171

	Art. Nr / Art.-No.	Wykonanie / Finish				
165	2372	mat chrom mat chrome	21	21	25	
166	Z017	mosiądz patynowany antique brass	52	25	25	16
167	Z017	mat chrom mat chrome	52	25	25	16
168	2409	chrom polished chrome	40	18	10	32
169	2409	mat chrom mat chrome	40	18	10	32
170	2810	chrom polished chrome	20	20	23	
171	2810	chrom z dekorem polished chrome with decoration	20	20	23	
172	2810	mat chrom mat chrome	20	20	23	



172



173



174



175



176



177







179



178



180

	Art. Nr / Art.-No.	Wykonanie / Finish					
173	Z044	mat chrom mat chrome	65	19	2/5		
174	Z044	chrom polished chrome	65	19	2/5		
175	2209	mat chrom / skóra mat chrome / leather	35	18			
176	2174	chrom polished chrome	26	12			
177	2281	mat chrom mat chrome	28	15			
178	3031	aluminium aluminium	25	13			
179	2555	mat chrom lakierowany mat chrome lacquered	38	32	28	16	
180	2370	mat chrom mat chrome	15	15	24		
181	2370	chrom polished chrome	15	15	24		
182	2267	mat chrom mat chrome	15	25			



181



182



183







184



185



186

	Art. Nr / Art.-No.	Wykonanie / Finish					
183	2995/192	chrom polished chrome	209	14	29		192
184	2995/192	mat chrom mat chrome	209	14	29		192
185	Z071	chrom polished chrome	179	16	32		160
186	2586/160	mat chrom/czarne tworzywo mat chrome/black plastic	170	11	34		160



187

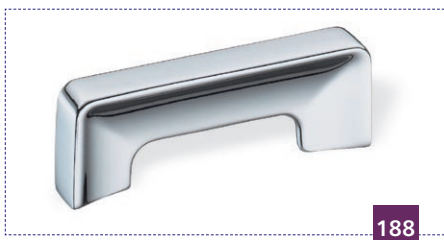



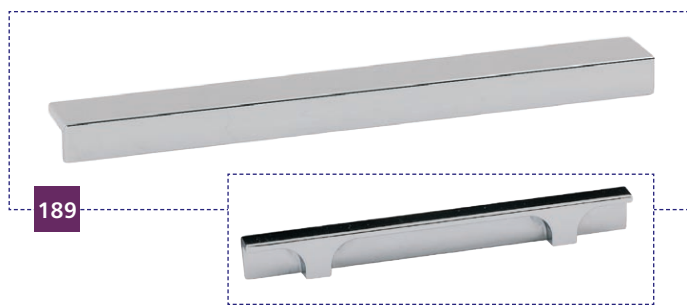

188

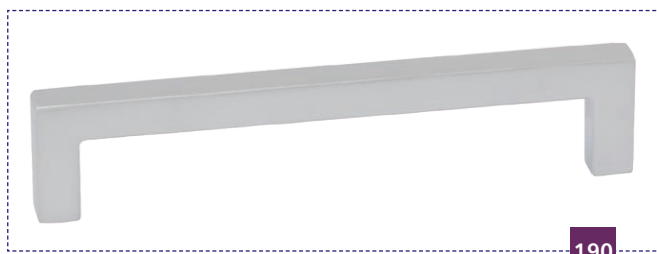

189



190

	Art. Nr / Art.-No.	Wykonanie / Finish					
187	Z074/192	mat chrom /mat chrome/ chrom /polished chrome/	201	12	32	192	
188	Z074/64	mat chrom /mat chrome/ chrom /polished chrome/	72	12	26	64	
189	2520/96	chrom polished chrome	150	10	17	96	
190	2334/128	mat chrom mat chrome	138	10	30	128	

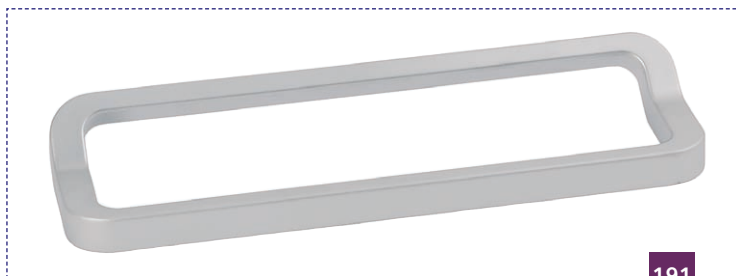

191





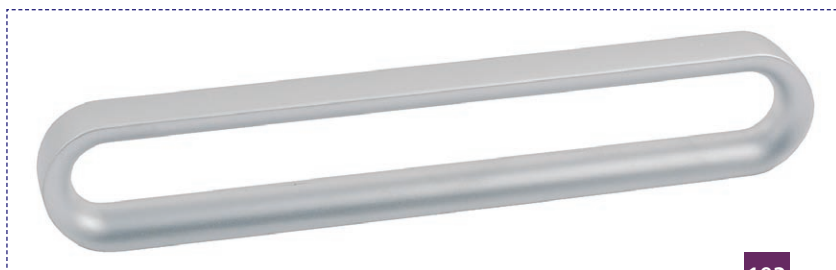

192



193



194

	Art. Nr / Art.-No.	Wykonanie / Finish					
191	2560	mat chrom mat chrome	169	50	30	160	
192	2560	chrom polished chrome	169	50	30	160	
193	2493	mat chrom mat chrome	201	18	35	160	
194	2493	chrom polished chrome	201	18	35	160	

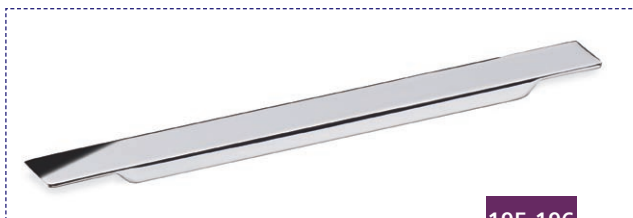

195-196

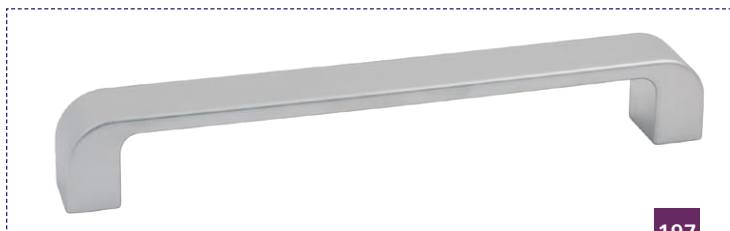

197







198



199-200



201

	Art. Nr / Art.-No.	Wykonanie / Finish					
195	Z045	chrom /polished chrome/	234	8	23	160	
196	Z045	chrom /polished chrome/ mat nikiel /mat nickel/	118	8	23	64	
197	2530	mat chrom /mat chrome/	208	25	30	192	
198	2424/160	mat chrom /mat chrome/	178	11	25	160	
199	2462/192	mat chrom /mat chrome/	214	15	33	192	
200	2462/96	mat chrom /mat chrome/	116	13	30	96	
201	Z119	chrom /polished chrome/	150	14	25	96	

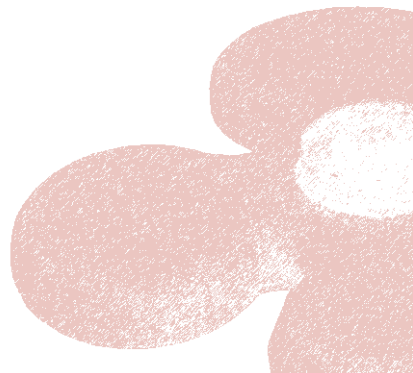



202



203





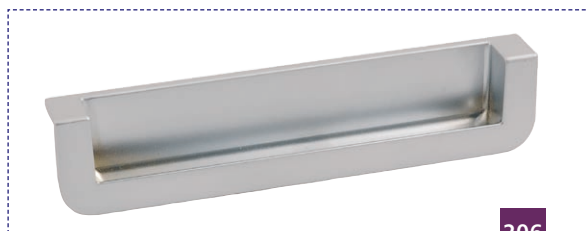

204



206



205

	Art. Nr / Art.-No.	Wykonanie / Finish				
202	2517	mat chrom / czarna guma mat chrome / black rubber	207	10	32	192
203	Z086	chrom / czarna guma polished chrome / black rubber	190	11	33	160
204	2396/128	mat chrom /mat chrome/	174	18	20	128
205	Z096	efekt stali nierdzewnej stainless steel effect/	100	80	1,5	64/64
206	2518	mat chrom lakierowany mat chrome lacquered	138	16	30	128
207	2396/32	mat chrom /mat chrome/	70	18	21	32

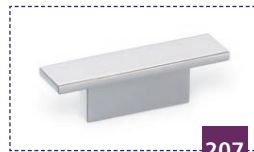

207

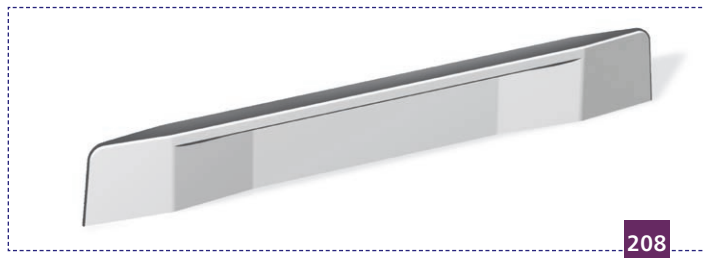

208



209

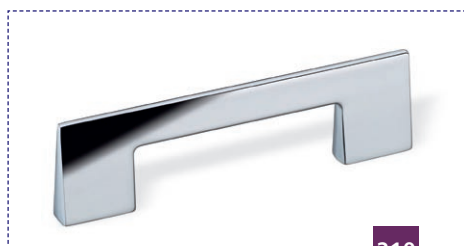

210



211

	Art. Nr / Art.-No.	Wykonanie / Finish				
208	Z083	mat chrom /mat chrome/ chrom /polished chrome/	224	9	31	160
209	Z106	mat chrom /mat chrome/ chrom /polished chrome/ efekt stali nierdzewnej /stainless steel effect/	243	12	37	192
210	Z106	mat chrom /mat chrome/ chrom /polished chrome/ efekt stali nierdzewnej /stainless steel effect/	122	11	32	96
211	Z118	chrom /polished chrome/	109	13	23	96

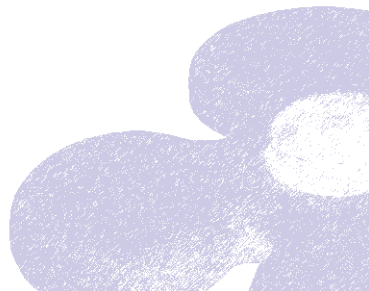







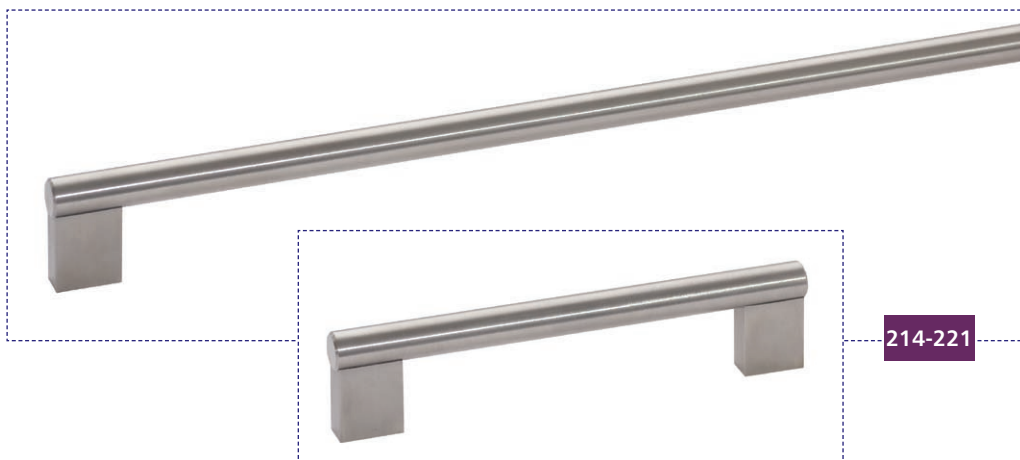

213



212



214-221

	Art. Nr / Art.-No.	Wykonanie / Finish					
212	2407/160	mat chrom /mat chrome/ mat nikiel /mat nickel/ efekt stali nierdzewnej /stainless steel effect/	168	30	35	-	160
213	2324	mat chrom /mat chrome/ mat nikiel /mat nickel/ mat nikiel szczotkowany /brushed mat nickel/	40	40	27	-	16
214	4135/128	stal nierdzewna stainless steel	150	12	34		128
215	4135/160	stal nierdzewna stainless steel	182	12	34		160
216	4135/192	stal nierdzewna stainless steel	214	12	34		192
217	4135/256	stal nierdzewna stainless steel	278	12	34		256
218	4135/320	stal nierdzewna stainless steel	342	12	34		320
219	4135/416	stal nierdzewna stainless steel	438	12	34		416
220	4135/512	stal nierdzewna stainless steel	534	12	34		512
221	4135/608	stal nierdzewna stainless steel	630	12	34		608



222





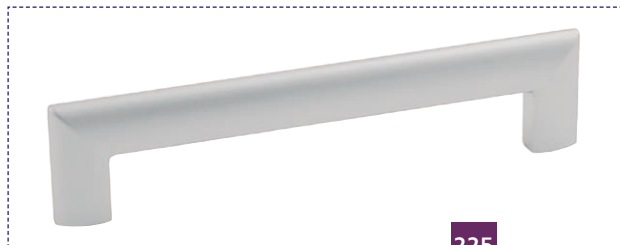

224

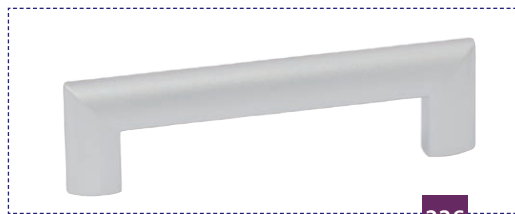







225

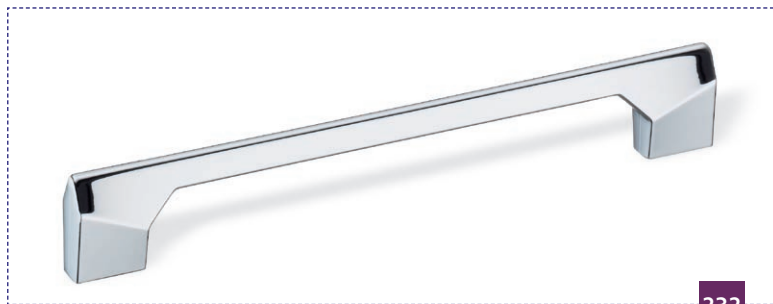
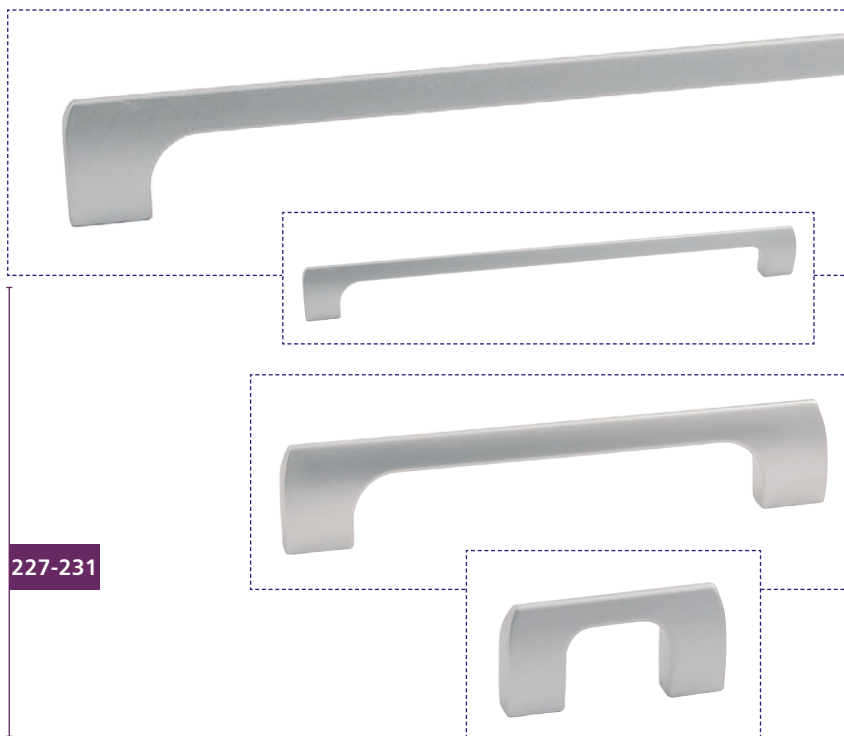

226

	Art. Nr / Art.-No.	Wykonanie / Finish					
222	Z088	chrom /polished chrome/	214	14	30	192	
223	Z088	mat chrom /mat chrome/	214	14	30	192	
224	Z088	efekt stali nierdzewnej /stainless steel effect/	214	14	30	192	
225	2455/128	mat chrom /mat chrome/	148	10	33	128	
226	2455/96	mat chrom /mat chrome/	116	10	33	96	



	Art. Nr / Art.-No.	Wykonanie / Finish					
227	2419/256	mat chrom mat chrome	275	12	29	256	
228	2419/192	mat chrom mat chrome	210	12	29	192	
229	2419/128	mat chrom mat chrome	146	12	29	128	
230	2419/64	mat chrom mat chrome	80	11	28	64	
231	2419/32	mat chrom mat chrome	50	10	25	32	
232	Z123	mat chrom /mat chrome/ chrom /polished chrome/ mat nikiel szczotkowy /brushed mat nickel/	189	12	29	160	

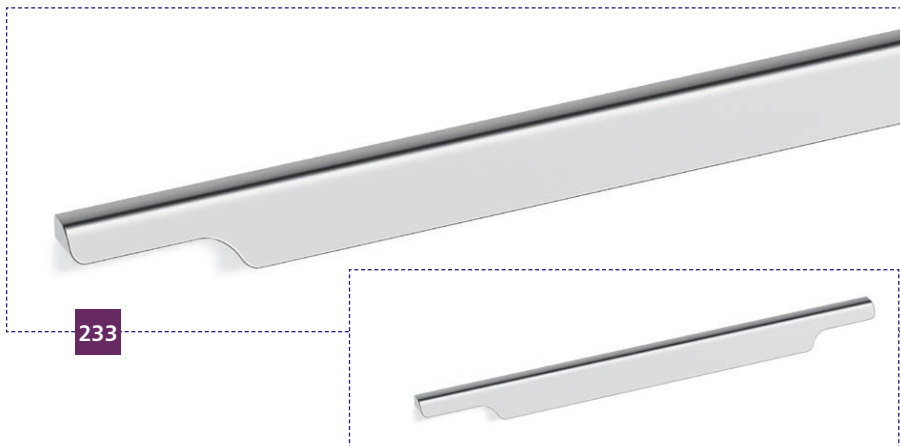





233



234



235

	Art. Nr / Art.-No.	Wykonanie / Finish					
233	Z087	mat chrom /mat chrome/ chrom /polished chrome/ chrom/czarny polished chrome/black chrom/biały polished chrome/white	380	24	22	320+352	
234	Z077	mat chrom /mat chrome/ chrom /polished chrome/ chrom/czarny polished chrome/black chrom/biały polished chrome/white	172	12	32	160	
235	Z082	mat chrom /mat chrome/ chrom /polished chrome/	191	20	32	160	



237

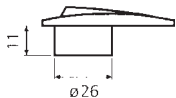

236



238



239



240



241



242



243









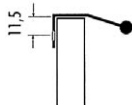



244



245-246



	Art. Nr / Art.-No.	Wykonanie / Finish					
236	2242	mat chrom /mat chrome/	55	32	7		
237	2466	mat chrom /mat chrome/	55	14	24	32	
238	2488	chrom /polished chrome/ mat chrom /mat chrome/	62	17	17	32	
239	2398	mat chrom /mat chrome/	45	8	25	32	
240	Z026	mat chrom /mat chrome/	42	11	27	32	
241	Z063	chrom /polished chrome/ mat chrom /mat chrome/	56	20	21	32	
242	2957	mat chrom /mat chrome/	40	20	25	32	
243	2266	mat chrom /mat chrome/	25	8	25	16	
244	Z084	chrom /polished chrome/ mat chrom /mat chrome/	26	28	36	16	
245	2361	uchwyt - metal - mat chrom handle - metal - mat chrome					
246	2361	uchwyt - metal - mat nikiel handle - metal - mat nickel	32	45	24	31	1,5 25





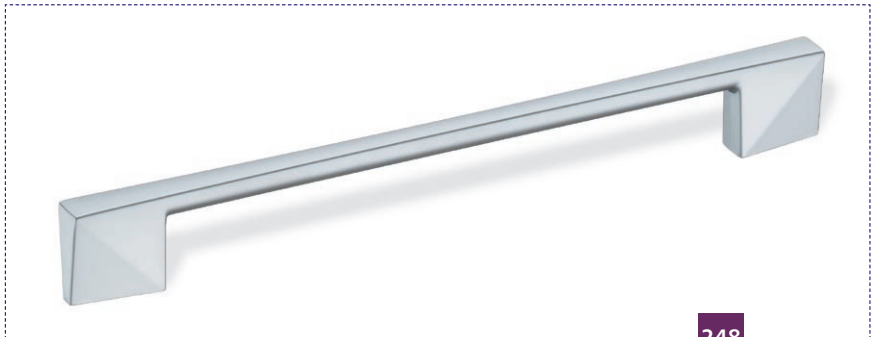

247

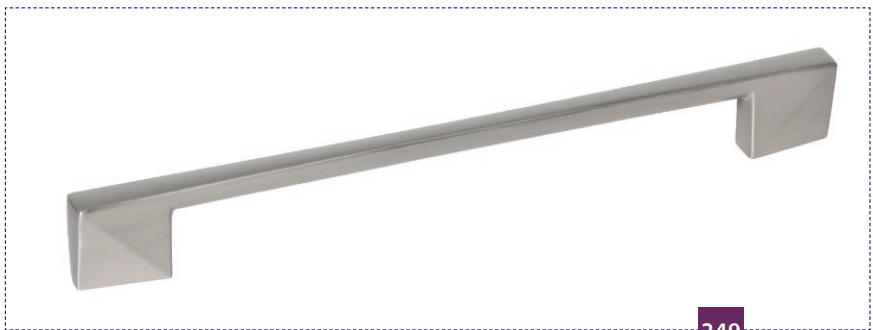

248



249

	Art. Nr / Art.-No.	Wykonanie / Finish					
247	Z094	chrom polished chrome	239	12	28		192
248	Z094	mat chrom mat chrome	239	12	28		192
249	Z094	efekt stali nierdzewnej stainless steel effect	239	12	28		192



250

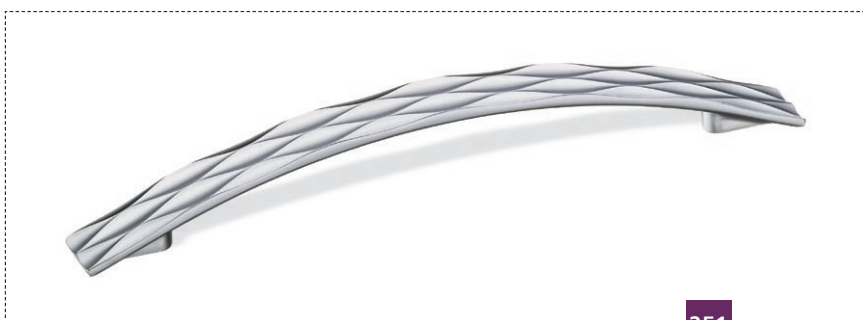

251

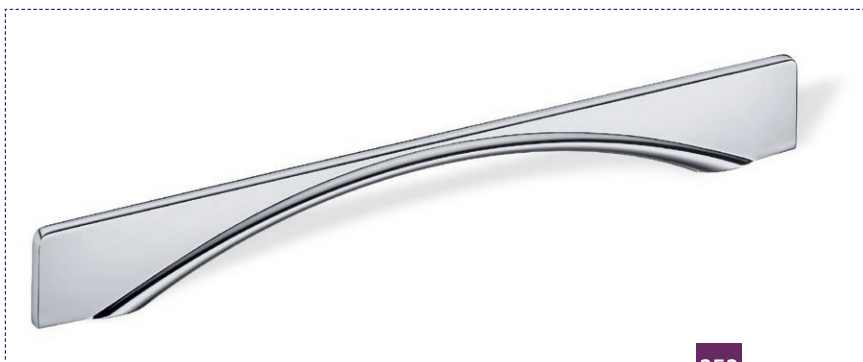

252

Art. Nr / Art.-No.		Wykonanie / Finish				
250	Z145	mat chrom /mat chrome/ chrom /polished chrome/ efekt stali nierdzewnej / stainless steel effect	229	26	30	160
251	Z150	mat chrom /mat chrome/ chrom /polished chrome/	204	22	27	160
252	Z132	chrom /polished chrome/	210	10	25	160







253

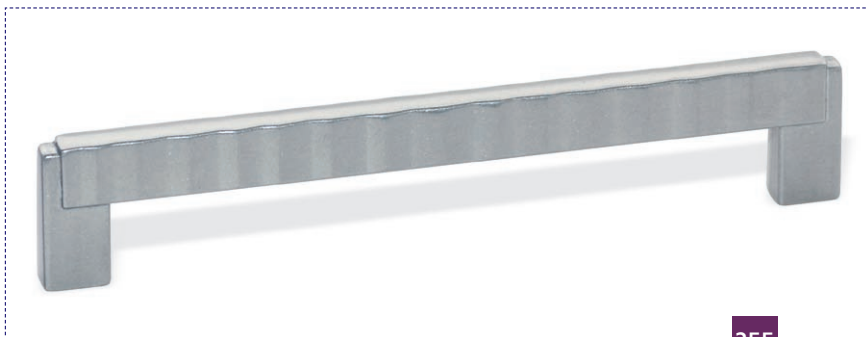

254



255

	Art. Nr / Art.-No.	Wykonanie / Finish					
253	Z133	efekt stali nierdzewnej stainless steel effect	178	10	34	160	
254	Z133	czarny lakier black lacquered	178	10	34	160	
255	Z133	szary cynk grey zinc	178	10	34	160	

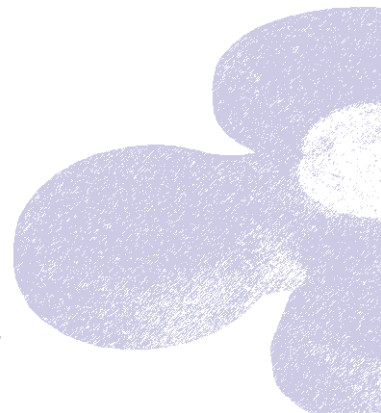



256



258



257



259



260





262



261



263

	Art. Nr / Art.-No.	Wykonanie / Finish			
256	Z033/38	złoty polysk polished gold	38	38	21
257	Z038/30	chrom polished chrome	30	30	18
258	Z038/38	mosiądz patynowany antique brass	38	38	21
259	Z038/30	mosiądz patynowany antique brass	30	30	18
260	Z034/38	chrom polished chrome	38	38	21
261	Z034/38	mat nikiel mat nickel	38	38	21
262	Z034/38	mosiądz patynowany antique brass	38	38	21
263	Z034/30	mosiądz patynowany antique brass	30	30	18



265



264





267



266



268-269

	Art. Nr / Art.-No.	Wykonanie / Finish					
264	2332/128	mosiądz patynowany antique brass	150	22	16		128
265	2276/28	mosiądz patynowany antique brass				25	28
266	2332/128	nikiel antyczny antique nickel	150	22	16		128
267	2276/28	nikiel antyczny antique nickel				25	28
268	Z054/192	mosiądz patynowany antique brass	202	22	27		192
269	Z054/96	mosiądz patynowany antique brass	107	22	27		96



271



270



272



273-274







275



276



277

	Art. Nr / Art.-No.	Wykonanie / Finish					
270	2541/128	mosiądz patynowany / antique brass	142	16	28		128
271	2991 + 2990	mosiądz patynowany / antique brass	25/45	25/21	28		
272	2978	mosiądz patynowany / antique brass	42	16	53		32
273	2232/128	mosiądz patynowany / antique brass	140	15	29		128
274	2232/96	mosiądz patynowany / antique brass	108	15	27		96
275	Z150	mosiądz patynowany / antique brass	204	22	27		160
276	Z342/96	mosiądz patynowany / antique brass	123	18	29		96
277	Z138	mosiądz patynowany / antique brass	84	36	15		64
278	Z137	mosiądz patynowany / antique brass	30	30	25		



278



279



280



282





281



283



284

	Art. Nr / Art.-No.	Wykonanie / Finish					
279	Z157	nikiel antyczny / antique nickel	226	21	29		192
280	Z136	nikiel antyczny / antique nickel	168	24	28		160
281	2366/128	mosiądz patynowany / antique brass	143	15	30		128
282	2267	mosiądz patynowany / antique brass		15	25		
283	2366/128	nikiel antyczny / antique nickel	143	15	30		128
284	2267	nikiel antyczny / antique nickel		15	25		



286



285



288



287



K



F



M



B

	Art. Nr / Art.-No.	Wykonanie / Finish				
285	K263	tworzywo - kotka plastic - cat	75	77	26	32
286	K263	tworzywo - żaba plastic - frog	75	77	26	32
287	K263	tworzywo - myszka plastic - mouse	75	77	26	32
288	K263	tworzywo - miś plastic - bear	75	77	26	32



289



290



291



292



293



294



295

	Art. Nr / Art.-No.	Wykonanie / Finish				
289	K074	tworzywo - różowy plastic - pink	77	73	28	
290	K074	tworzywo - niebieski plastic - blue	77	73	28	
291	K074	tworzywo - pomarańcz przezroczysty plastic - orange transparent	77	73	28	
292	K074	tworzywo - żółty przezroczysty plastic - yellow transparent	77	73	28	
293	K074	tworzywo - wrzosowy plastic - heather	77	73	28	
294	6551	tworzywo - mat chrom lakierowany plastic - mat chrome lacquered	61	58	23	16
295	6551	tworzywo - mat złoty chrom lakierowany plastic - mat gold chrome lacquered	61	58	23	16



SPECJALNE
SPECIALS

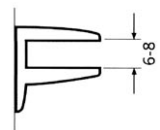
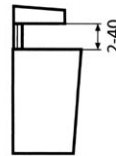
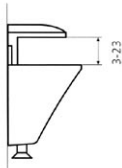
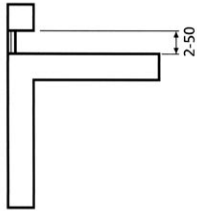

	Art. Nr / Art.-No.	Wykonanie / Finish
296	2943	metal - mat chrom metal - mat chrome	64	100	18	118
297	2943	metal - chrom metal - polished chrome	64	100	18	118
298	2573	metal - mat chrom lakierowany metal - mat chrome lacquered	36	38	52/72	16
299	2947	metal - mat chrom lakierowany metal - mat chrome lacquered	26	30	40	72
300	2918	wspornik - metal - mat chrom support - metal - mat chrome
301	2918	wspornik - metal - chrom support - metal - polished chrome	0/32	50	25	25



303



302

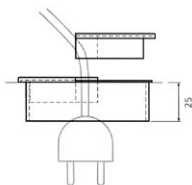



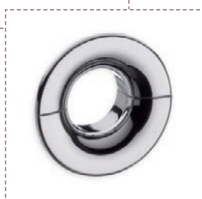

306-308







304-305



	Art. Nr / Art.-No.	Wykonanie / Finish				
302	6796/6797	przepust kablowy - tworzywo - mat chrom lakierowany cable culvert - plastic - mat chrome lacquered	87	87	4/26	79/83
303	6796/6797	przepust kablowy - tworzywo - mat nikiel lakierowany cable culvert - plastic - mat nickel lacquered	87	87	4/26	79/83
304	K094/80+6797	przepust kablowy - tworzywo - mat chrom lakierowany cable culvert - plastic - mat chrome lacquered			5	79/88
305	K094/80+6797	przepust kablowy - tworzywo - mat nikiel lakierowany cable culvert - plastic - mat nickel lacquered			5	79/88
306	K094/60	przepust kablowy - tworzywo - mat chrom lakierowany cable culvert - plastic - mat chrome lacquered			3	59/67
307	K094/60	przepust kablowy - tworzywo - mat nikiel lakierowany cable culvert - plastic - mat nickel lacquered			3	59/67
308	K094/60	przepust kablowy - tworzywo - chrom cable culvert - plastic - polished chrome			3	59/67



	Art. Nr / Art.-No.	Wykonanie / Finish				
309	Z084	mat chrom /mat chrome/ chrom /polished chrome/	16	36	26	28
310	K289	metal/tworzywo - mat chrom metal/plastic mat chrome	64	3	60	131
311	Z316	metal - mat chrom /metal - mat chrome/ metal -mat nikiel /metal - mat nickel/	32	123	16	70
312	Z345	metal - mat chrom /metal - mat chrome/ metal -mat nikiel /metal - mat nickel/	32	68	16	51
313	Z093	chrom /polished chrome/ mat chrom /mat chrome/ mat nikiel / mat nickel	32	47	65	73
314	Z971	chrom /polished chrome/	16	23	9	45
315	Z044	chrom polished chrome	65	19	2/5	
316	Z044	mat chrom mat chrome	65	19	2/5	





318



317



319



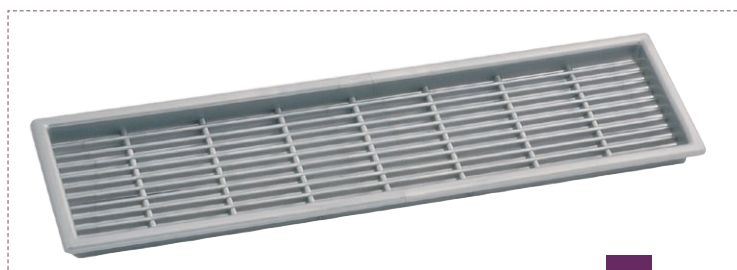

320

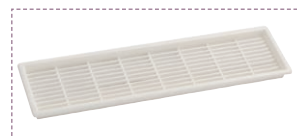
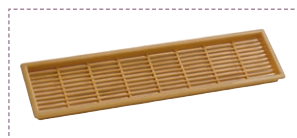

321



	Art. Nr / Art.-No.	Wykonanie / Finish	   
317	6800/6801	stopka - tworzywo - mat chrom lakierowany foot - plastic - mat chrome lacquered	120 120 90 2x64
318	3613	stopka - metal - mat chrom lakierowany foot - metal - mat chrome lacquered	80 60 80 2x32
319	6474	tworzywo - chrom plastic - polished chrome	22 22 3
320	6474	tworzywo - mat chrom lakierowany plastic - mat chrome lacquered	22 22 3
321	6416	kratka wentylacyjna - tworzywo - uni: mat chrom, olcha, wiśnia, brąz, biały ventilation grating - plastic - unicolour: mat chrome, alder, cherry, brown, white	   214/220 50/56 6/9

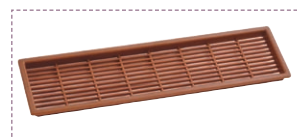



323







322

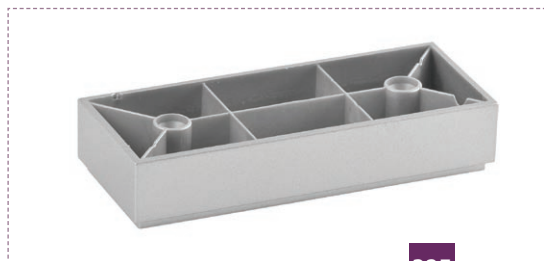

324



325

	Art. Nr / Art.-No.	Wykonanie / Finish	     
322	K174	stopka - tworzywo - mat chrom lakierowany foot - plastic - mat chrome lacquered	100 50 50 64
323	6699	stopka - tworzywo - chrom foot - plastic - chrome	106 40/58
324	K029	stopka - tworzywo - mat chrom lakierowany foot - plastic - mat chrome lacquered	79 53 60 32
325	K160	stopka - tworzywo - mat chrom lakierowany foot - plastic - mat chrome lacquered	100 40 20 64



326-327





328



329



330-331

	Art. Nr / Art.-No.	Wykonanie / Finish				
326	K042	stopka - tworzywo - mat chrom lakierowany foot - plastic - mat chrome lacquered	56	56	15	32/32
327	K042	stopka - tworzywo - chrom foot - plastic - polished chrome	56	56	15	32/32
328	K134	stopka - tworzywo - mat chrom lakierowany foot - plastic - mat chrome lacquered	100	100	100	32/32
329	6619	stopka - tworzywo - mat chrom lakierowany foot - plastic - mat chrome lacquered	100	32	68	64
330	K269	stopka - tworzywo - mat chrom lakierowany - LED foot - plastic - mat chrome lacquered - LED	100	100	38	32/64
331	K268	stopka - tworzywo - mat chrom lakierowany foot - plastic - mat chrome lacquered	100	100	38	32/64



333

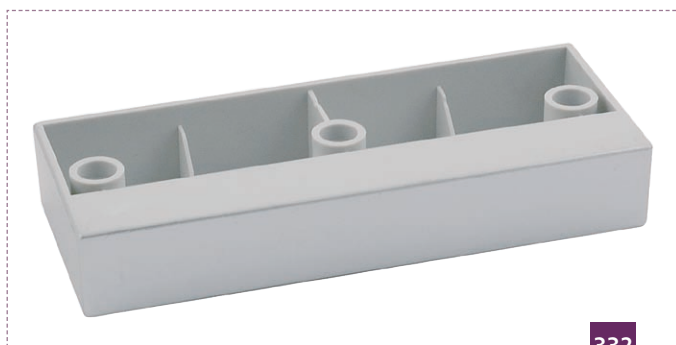

332



335



334



336-337

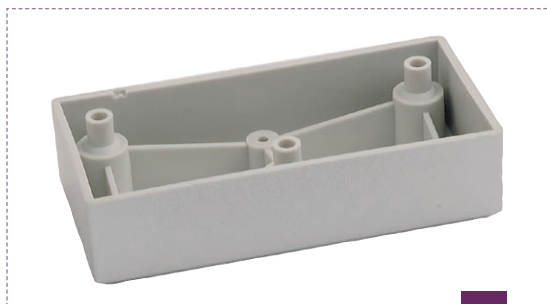

338

	Art. Nr / Art.-No.	Wykonanie / Finish				
332	6154	tworzywo - mat chrom lakierowany plastic - mat chrome lacquered	151	61	25	2x64
333	6603	tworzywo - mat chrom lakierowany plastic - mat chrome lacquered	53	53	63	32
334	6556	tworzywo - mat chrom lakierowany plastic - mat chrome lacquered	62	62	60	32
335	6435/25	tworzywo - mat chrom lakierowany plastic - mat chrome lacquered tworzywo - chrom plastic - chrome	60	60	25	32
336	6601	tworzywo - mat chrom lakierowany plastic - mat chrome lacquered	56	56	20	2x32
337	6601	stopka - tworzywo - chrom foot - plastic - polished chrome	56	56	20	2x32
338	6838	tworzywo - mat chrom lakierowany plastic - mat chrome lacquered	120	60	30	32/96



339



340



341

	Art. Nr / Art.-No.	Wykonanie / Finish	     
339	6809/4278	kółko - metal/tworzywo castor - metal/plastic	81 47 94 80 40 32/32
340	6766/4278	kółko z hamulcem - metal/tworzywo castor with brake - metal/plastic	102 47 94 80 40 32/32
341	Z099/4278	kółko - metal/tworzywo castor - metal/plastic	70 57 80

pl.schwinn-group.com

Schwinn Polska Sp. z o.o.
ul. Nad Drwiną 4
30-741 Kraków
Tel. +48 (12) 650 80 30
Tel. +48 (12) 653 06 35
Fax +48 (12) 653 50 18
schwinn@schwinn.com.pl

